

HI TECH  EXPRESSIONS™

AwardWare™

**Design & Print Awards, Certificates,
Ribbons, Tickets, Coupons,
Checks & More!**





HI TECH  EXPRESSIONS™

AwardWare™

Copyright © 1987 by Hi Tech Expressions, Inc. All rights reserved.

No part of the software program or user's manual may be reproduced, transmitted, or translated, in whole or part, in any form by any means other than for specific purpose set forth in the user's manual which entitles the original purchaser of this product to use the product for his or her own use, but does not grant the right to such user to sell or transfer reproductions of the software or manual to other parties in any way, nor to rent or lease the product to others without prior written permission of Hi Tech Expressions. AwardWare™ and Hi Tech Expressions™ are trademarks of Hi Tech Expressions, Inc., 1700 N.W. 65 Avenue, Suite 9, Plantation, Florida 33313.

AwardWare was developed by:
Bob Smith, Project Director/Programmer
Joan Ziegler, Marketing Director
Kathleen Callery, Design Coordinator/Programmer
Sean Puckett, Conceptual Design/Programmer

Jeff Jones, Programmer
Cecelia Rodriguez, Programmer
Heidi Beckemeier, Computer Graphics
Vicki Finnk-Cortina, Manual Design



LIMITED WARRANTY



Hi Tech Expressions™ warrants the physical diskette furnished by Hi Tech Expressions to be free from defects in material and workmanship under normal use for a period of 90 days from date of delivery to the original purchaser as evidenced by a copy of the purchase receipt.

Hi Tech Expressions will replace any such defective diskette which is promptly returned to it free of charge.

Hi Tech Expressions™ does not warrant that the functions contained in any computer software program will meet customer requirements or that operation of any program will be uninterrupted or error-free. This product is sold "AS IS" as to quality and performance.

The entire risk of use is assumed by customer.

THE FOREGOING WARRANTY IS IN LIEU OF ALL OTHER WARRANTIES, EXPRESS OR IMPLIED, INCLUDING BUT NOT LIMITED TO THE IMPLIED WARRANTIES OF MERCHANTABILITY AND FITNESS FOR A PARTICULAR PURPOSE. IN NO EVENT WILL HI TECH EXPRESSIONS BE LIABLE FOR SPECIAL OR CONSEQUENTIAL DAMAGES EVEN IF HI TECH EXPRESSIONS HAS BEEN ADVISED OF THE POSSIBILITY OF SUCH DAMAGES.

AWARDWARE REGISTRATION



To be eligible for customer support on this product, include a copy of your original sales receipt and return it with this form to:
Hi Tech Expressions, Inc., Software Registration Dept., 1700 N.W. 65 Avenue, Suite 9, Plantation, Florida 33313.

NAME _____ AGE _____

STREET _____ PHONE (_____) _____

CITY _____ STATE _____ ZIP _____

OCCUPATION _____

PLACE PURCHASED _____ DATE OF PURCHASE _____

COMPUTER BRAND AND MODEL _____

PRINTER BRAND AND MODEL _____ INTERFACE _____

(Don't forget to fill out the back side of this form too!)

AWARDWARE REGISTRATION



Where did you first hear about AwardWare?

- Store Magazine Newspaper Ad Article Other

Please specify: _____

Do you have any recommendations for improvement of this product? _____

Do you own any other Hi Tech Expressions products? _____

Which ones? _____

Are there any other types of programs not presently on the market you would like to buy? Please explain: _____

Additional comments: _____

All our customers are very valuable to us. By answering these questions, you've helped us to serve you better in the future.
Thanks!

CONTENTS



INTRODUCTION

Getting Acquainted	2
Example Award	3

AWARDWARE MAIN MENU

Printer Setup	5
Create a QuickAward	6
Create Awards and More	7
<i>Edit Last Template/Award</i>	7
<i>Template Legend</i>	7
<i>Award/License--Vertical</i>	8
<i>Award/License--Horizontal</i>	12
<i>Award/License--5x7 inch</i>	15
<i>Award/License--8x10 inch</i>	16
<i>Letterhead/Memo</i>	17
<i>Checks/Tickets/Coupons</i>	18
<i>Ribbons</i>	19
<i>Miscellaneous</i>	19
Create an AwardDisk	21

AWARDWARE DESIGN FEATURES

Borders	22
Fonts (Type Styles)	23
Graphics	24
Seals/Signature	26

PROBLEM SOLVING/RE-ORDER INFORMATION 27

ADDING FLAIR/MORE TO COME 28

INTRODUCTION

Getting Acquainted



Welcome to AwardWare! With AwardWare you can express creativity in a multitude of ways by mixing and matching your own text with a selection of border designs, fonts (type styles), graphics, and seal designs. You can also design and print awards, licenses, tickets, coupons, checks, prize ribbons, letterheads, memos, rewards, signs, paper trophies, and more. For effective use of AwardWare, please use this manual along with the program. Before you start the program, we suggest you make a back-up copy of your AwardWare disk.

A Reference insert for your specific computer is included with this manual. Please look over the Reference insert before you start creating those special awards for information on computer equipment, on printer setup, on booting your system, and on the use of important keyboard keys.

INTRODUCTION

Example Award



To acquaint you with the program we will take you step-by-step through each feature of AwardWare. You will create the following award, along with our help.



The AwardWare Main Menu is the first menu that appears. The Main Menu is your path to creating and printing awards.

1. *Printer Setup* is highlighted as you enter the Main Menu. Press the Return key to select *Printer Setup*. As you enter the *Printer Setup* menu, use the Reference insert to guide you. Testing the Printer Setup is explained in the "Problem Solving" section of this manual (page 27).

This step is essential for the successful printing of awards and **MUST BE DONE THE FIRST TIME YOU USE THE PROGRAM**. Repeat this step **ONLY** if you change printers.

2. For now, cursor down past *Create a QuickAward* to *Create Awards and More* and press Return.
3. On this screen you choose to edit or create an award. For now, cursor down past "Edit Last Template/Award" to "Award/License" and press Return. You will be asked to enter a template number. Templates illustrate the location of the features that make up your award. All template designs are assigned a template number, starting on page 8 of this manual.

Apple/Atari/Commodore: Use the up and down cursor keys to choose template number "1" and press Return.

IBM: Type 1 and press Return.

INTRODUCTION

Example Award (continued)



The following screen will appear:

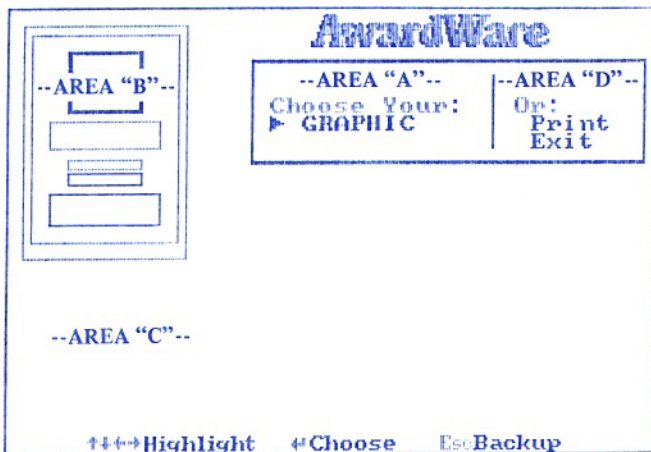

4. On this next screen you will be able to choose features that make up your award (border, graphic, text, signature, and seal). The following is a brief description of each section of this screen.

Area A: This is where you choose features contained in the template chosen (border, graphic, text, signature, and seal). To access each feature use the up and down cursor movement keys (see the Reference insert).

Area B: This is the template design. Notice the highlighted boxes as you cursor up and down. They work together with the highlighted features in Area A.

Area C: This area displays a list of choices for the feature selected in Area A. To access these choices, use the up and down cursor keys.

Area D: Use the right and left cursor keys to move between Area A and Area D. Once in Area D, use the up and down cursor keys to make your choice.

5. Highlight "Border" in Area A and press Return. A selection of borders will appear in Area C (borders are shown on page 22 of this manual). Cursor down until you see the word "Star" and press Return. The Star border has now been saved.
6. You will automatically return to Area A. Press the down cursor key to highlight "Graphic" and press Return. A list of graphics will appear in Area C (graphics can be seen on page 24 of this manual). Cursor down to the word "Computer" and press Return. The Computer graphic has now been saved.
7. You are now back in Area A again. Cursor down to highlight "Text" and press Return. A list of fonts (see page 23 of this manual for examples) appears in Area C. Highlight "Block" and press Return.

INTRODUCTION

Example Award (continued)



Type: AWARDWARE and press Return.
(Apple/Atari/Commodore users should press the Escape key to get out of the Text mode.)

If you've made a mistake, see "Important Keys" on your Reference insert. Back-up and Delete keys are explained.

8. We're back in Area A again. Cursor down. "Text" will again be highlighted. Press Return. This is the second box of text for this particular template. Some templates have more text boxes than others. See the actual template designs on page 8 of this manual.

Highlight "Block" and press Return. Two lines for entering text will appear.

Type: WELCOMES and press Return.
Type: (Your Name) and press Return. (Apple/Atari/Commodore users should press Escape key.)

9. Here we are, back in Area A again. Cursor down to highlight "Signature" and press Return. Different types of Signature boxes are listed in Area C (refer to page 26 for illustrations). Cursor down to "Left Side" and press Return. A list of "Seals" will appear (turn to page 26 of this manual for a look at the Seals). Highlight "Ewe's Great" and press Return.

We have now completed our award. If you would like to print this award, cursor right from Area A to Area D to highlight "Print" and press Return. Apple/Atari/Commodore users should choose F (final) for a darker copy, but a longer print time, or D (draft) for a lighter copy, but a shorter print time. This will start the printing process. The printer data (line segments) will appear on screen. For IBM final (darker copies) print-outs, see your Reference insert. By selecting to "Print" you have automatically saved the award we just created. Only the last award printed is saved. If you would like to create your own award at this time, cursor down to "Exit" and press Return. If you "Exit" before printing, the award will NOT be saved.

Now that you've become an expert award maker, the rest is easy. On the next few pages are all the features available with AwardWare.

AWARDWARE MAIN MENU

Printer Setup

Let's start with the AwardWare Main Menu. The Main Menu leads you through AwardWare. The first choice in the Main Menu is *Printer Setup*.

See the Reference insert to help you choose the correct Printer Setup for your system. **THIS STEP MUST BE DONE THE FIRST TIME YOU USE THE PROGRAM.** Repeat this step **ONLY** if you change printers.

AWARDWARE MAIN MENU

Create a QuickAward



With a QuickAward, we have already chosen some of the award features for you, to make creating this award quick and easy. QuickAwards have limited feature choices, some

have no choices at all. The number of QuickAwards may vary by computer type because of space limitations. QuickAwards are NOT saved after you have printed them.

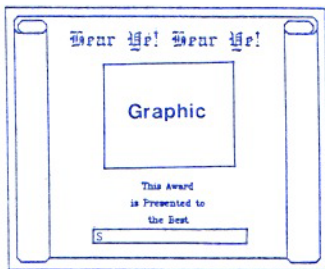

AWARD

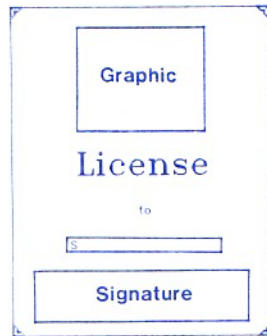

LICENSE



LETTERHEAD

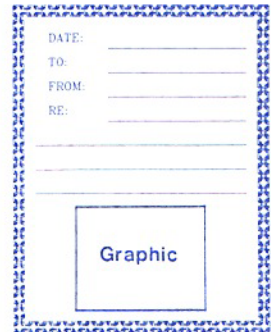

MEMO

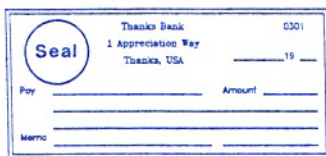

CHECK

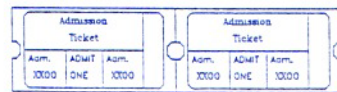
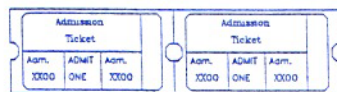

TICKET

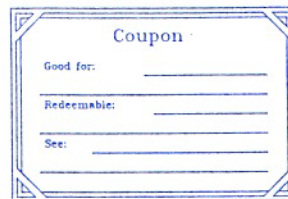

COUPON

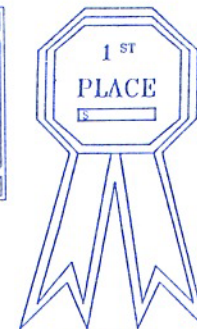

RIBBON



TROPHY

AWARDWARE MAIN MENU

Create Awards and More
Edit Last Template/Award
Template Legend









Edit Last Template/Award

After choosing *Create Awards and More* from the Main Menu, a menu appears with “Edit Last Template/Award” already highlighted. By choosing to edit an award you can make changes on the last award printed. This is useful when dedicating multiple awards of the same design to a group of people (such as Mrs. Peabody’s Third Grade).

Template Legend

The *Template Legend* explains how the symbols are used on the template designs that follow.

TEMPLATE LEGEND	
Border	= All the way around
	= Corner border ONLY
 Graphic	= Location of graphic
 Seal	= Location of seal
 Signature	= Location of signature box
TEXT SIZES	
	= LARGE
	= MEDIUM
	= SMALL

AWARDWARE MAIN MENU

Create Awards and More Award/License-- Vertical



Create Awards and More has several categories. After choosing a category (for example Award/License), enter the template number. Award/license has many different template designs that are suitable for framing, including vertical, horizontal, 5x7 inch, and 8x10 inch formats. See the Template Legend on page 7 for reference on the following templates.

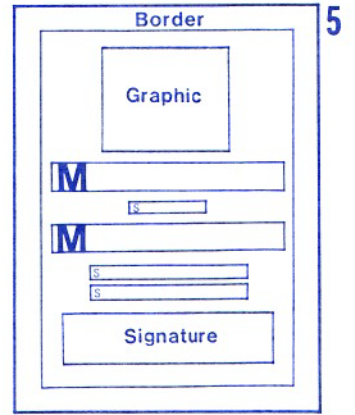
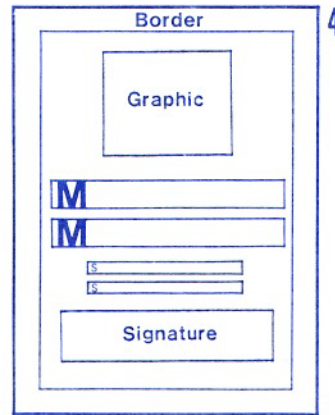
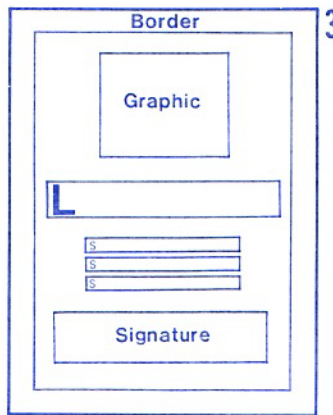
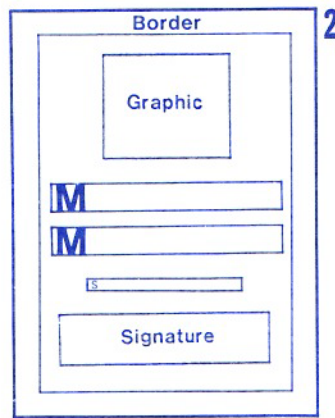
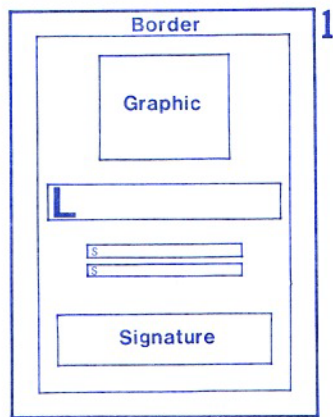

AWARDWARE MAIN MENU

Create Awards and More
Award/License-- Vertical

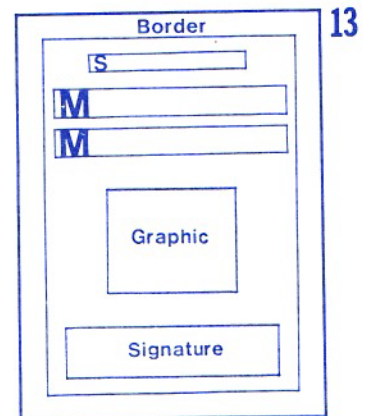
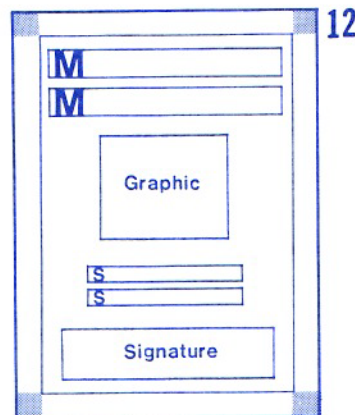
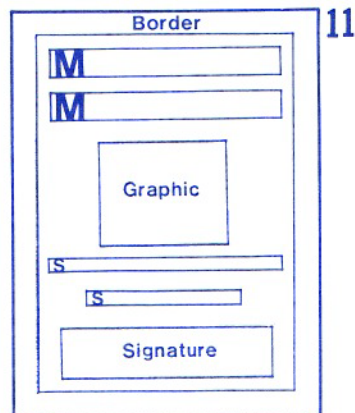
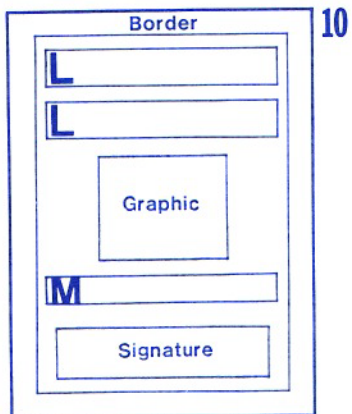
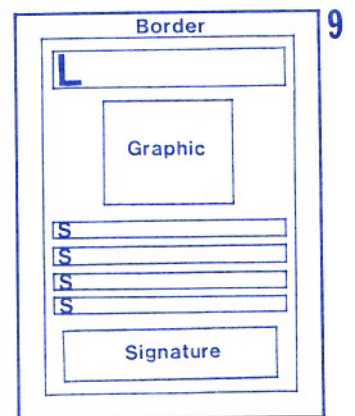
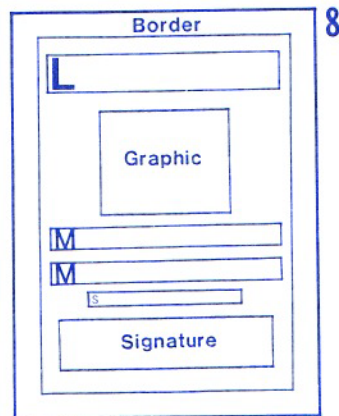
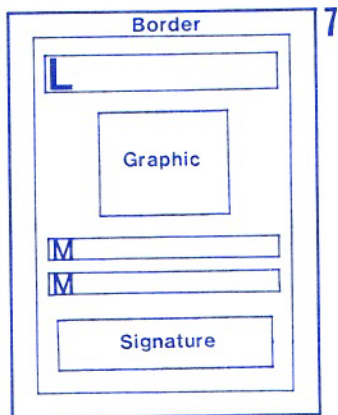
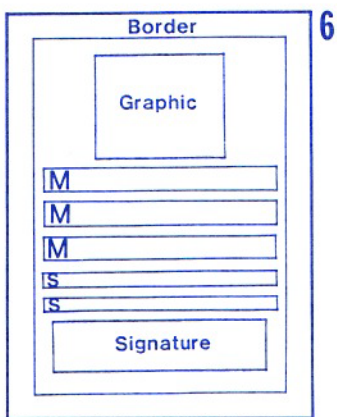

AWARDWARE MAIN MENU

Create Awards and More
Award/License-- Vertical



14

Border

M

M

M

Graphic

S

Signature

15

Border

M

M

M

Graphic

S

S

Signature

16

Border

L

L

S

S

Graphic

Signature

17

Border

L

M

M

M

M

Signature

18

Border

L

L

S

L

L

Signature

19

Border

L

S

S

L

L

L

Signature

20

Border

L

L

S

S

L

L

Signature

21

Border

L

S

M

M

M

M

M

Signature

AWARDWARE MAIN MENU

Create Awards and More
Award/License-- Vertical



22

Border

S

L

L

S

S

S

S

Signature

23

Border

S

S

S

L

L

L

L

Signature

24

Border

L

L

L

L

S

S

S

Signature

25

Border

S

L

S

S

S

S

S

S

S

Signature

26

Border

S

S

L

L

S

S

S

S

S

S

Signature

27

Border

M

M

M

M

S

S

S

S

S

S

S

Signature

28

Border

L

S

S

S

S

S

S

S

S

S

S

Signature

29

Border

S

S

S

L

S

S

S

S

S

S

S

Signature

AWARDWARE MAIN MENU

Create Awards and More
Award/License--Horizontal

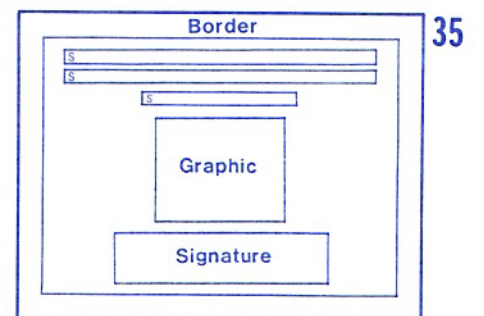
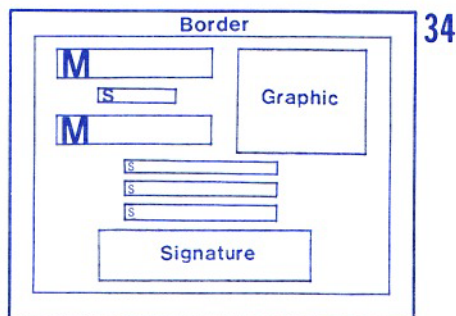
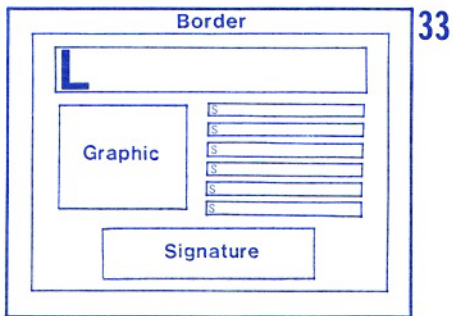
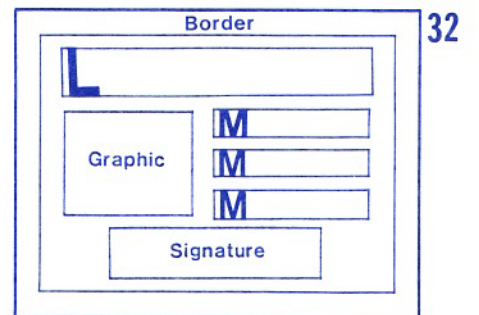
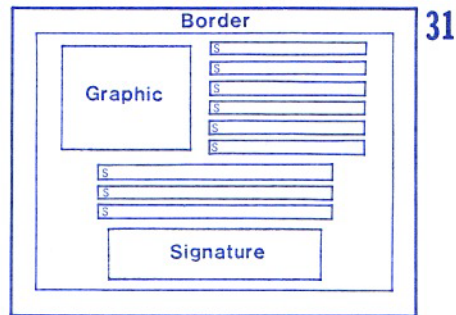
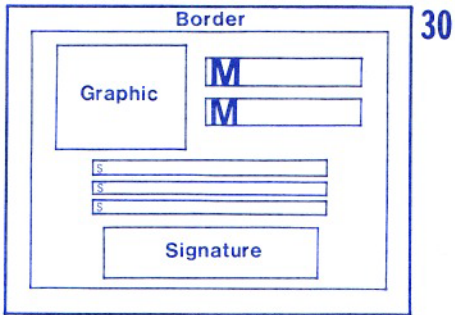

AWARDWARE MAIN MENU

Create Awards and More
Award/License--Horizontal

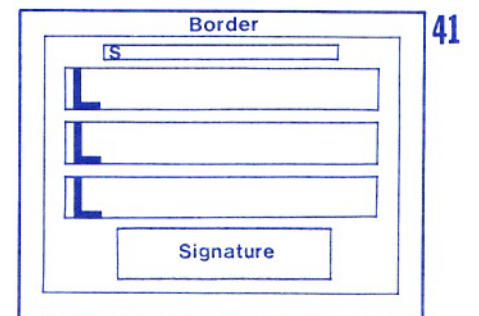
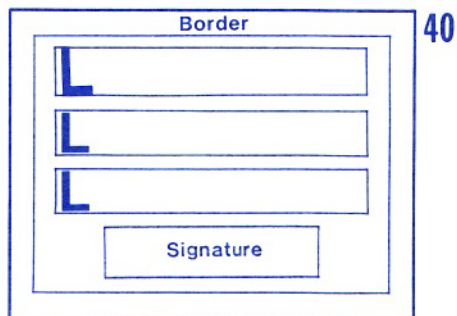
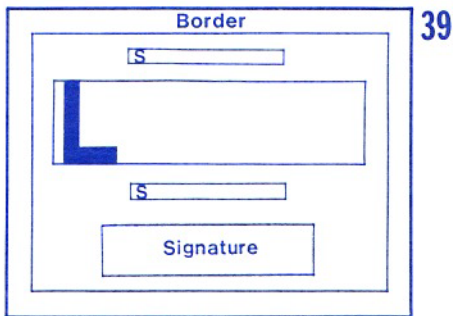
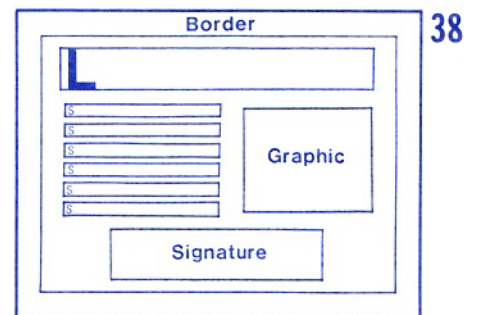
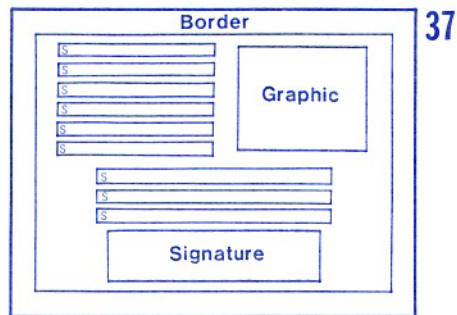
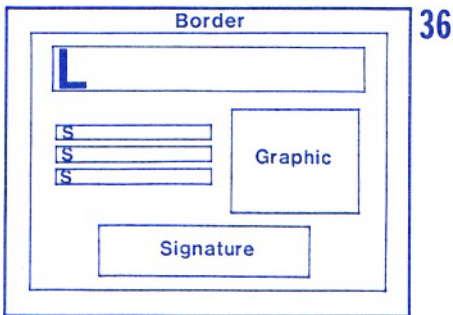

AWARDWARE MAIN MENU

Create Awards and More
Award/License--Horizontal

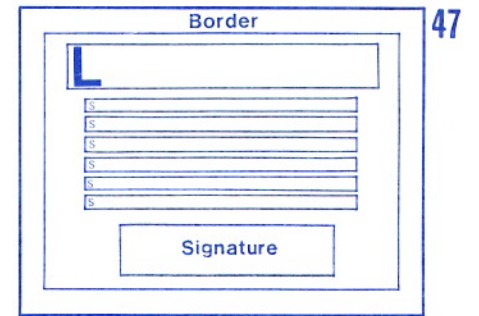
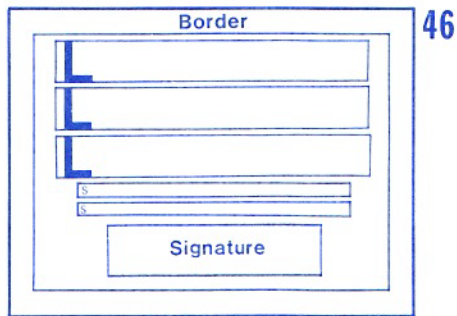
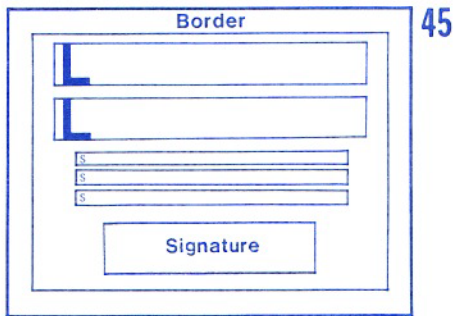
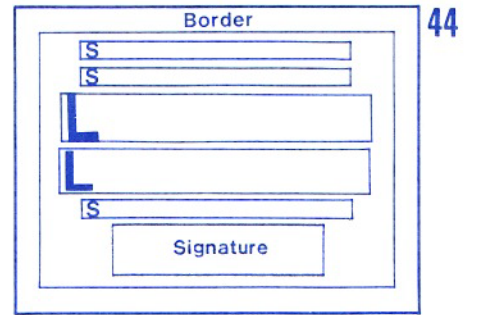
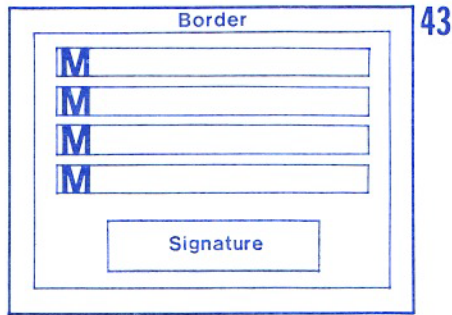
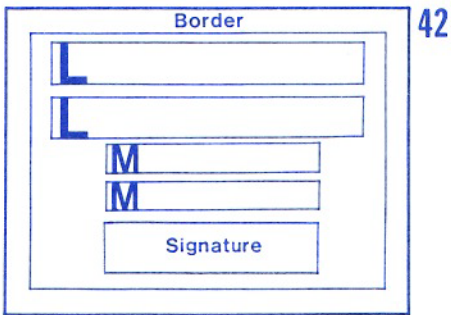

AWARDWARE MAIN MENU

Create Awards and More

Award/License--Horizontal/5x7 inch



Horizontal

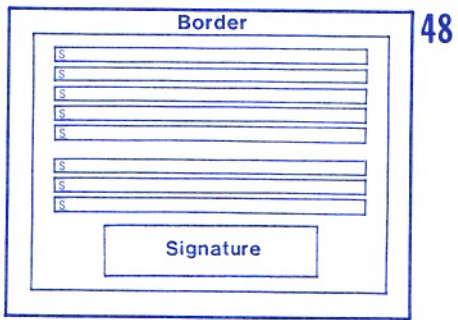

5x7 inch

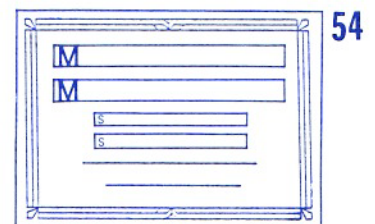
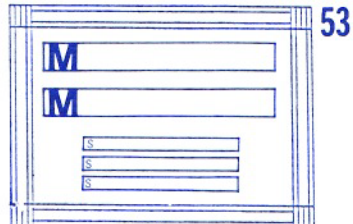
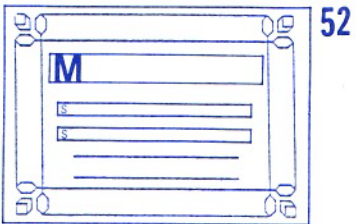
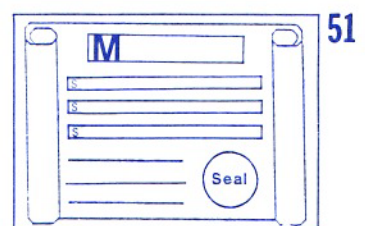
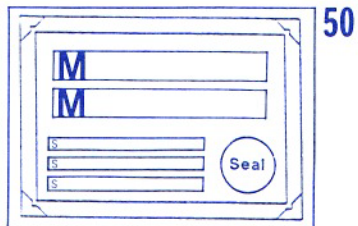
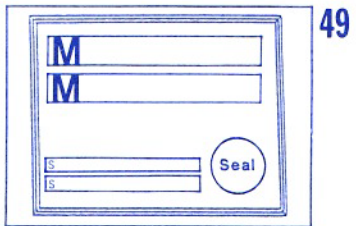

AWARDWARE MAIN MENU

Create Awards and More
Award/License--8x10 inch

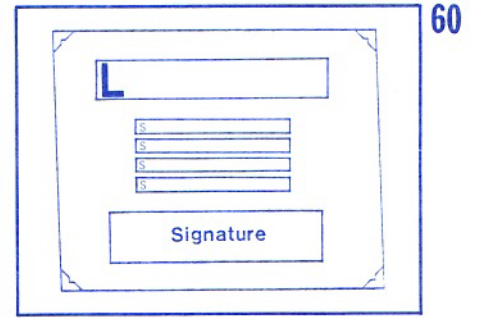
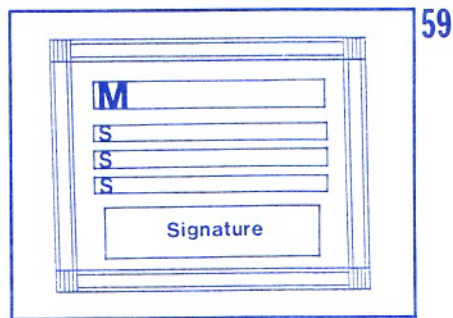
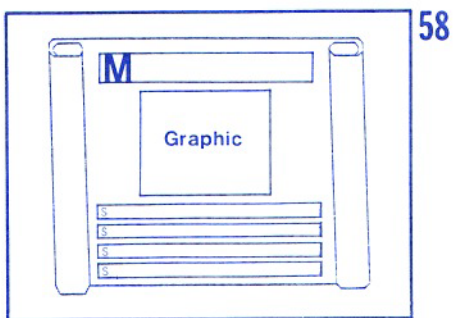
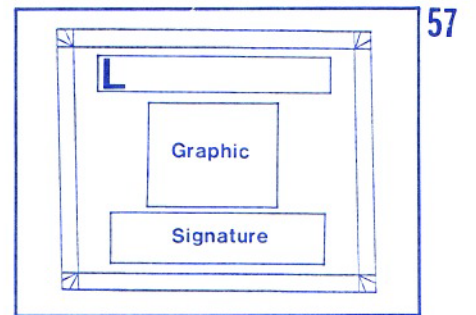
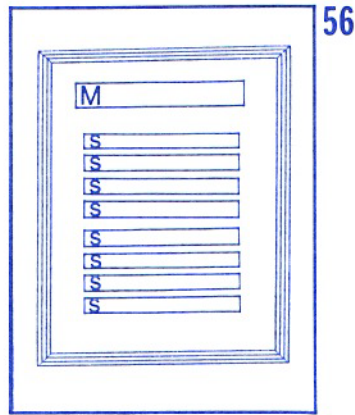
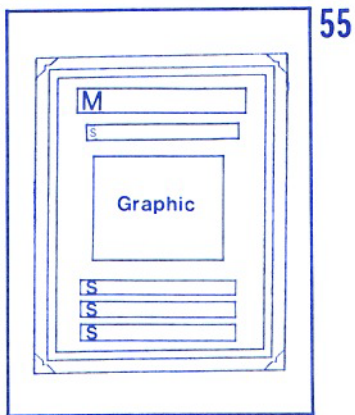

AWARDWARE MAIN MENU

Create Awards and More Checks/Tickets/Coupons



These template designs allow you to express humorous ideas in the form of checks, tickets, and coupons. Some

templates are completed for you. Refer to the Template Legend on page 7 for help.

1

Seal

0301

Pay _____ Amount _____

Memo _____

2

0301

Pay _____ Amount _____

Memo _____

5

Coupon

Good for: _____

Redeemable: _____

See: _____

3

4

M

S

S

S

S

S

6

7

AWARDWARE MAIN MENU

Create Awards and More Ribbons

With these template designs you can create a variety of prize ribbons (1st, 2nd, 3rd, etc.). Use the Template Legend on page 7 for reference.

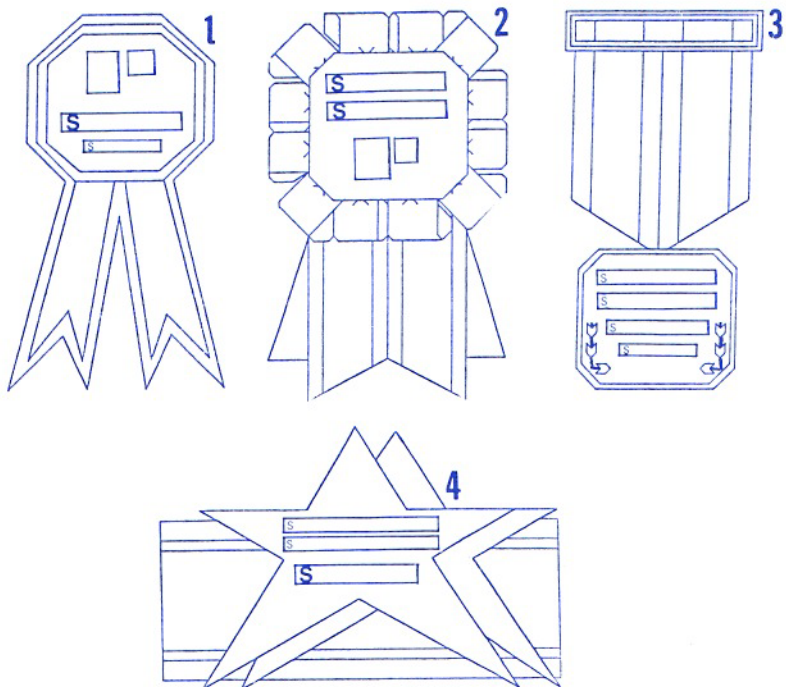

Create Awards and More Miscellaneous

If you're looking for MORE in awards, this is it! With these specially designed templates (signs, trophies, keys, newspapers, etc.) you can acknowledge those important events (baby announcements, car for sale, etc.). See the Template Legend on page 7 for help in filling in these templates.

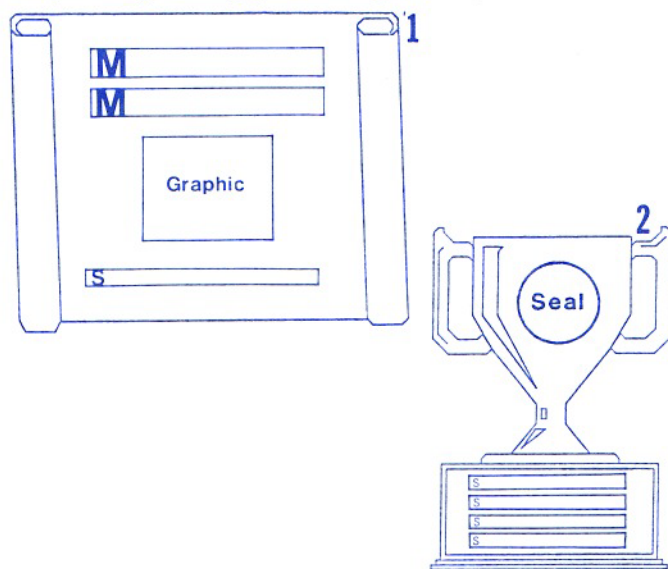

AWARDWARE MAIN MENU

Create Awards and More
Miscellaneous

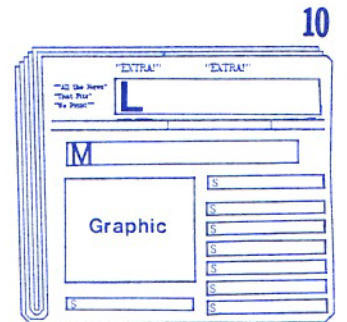
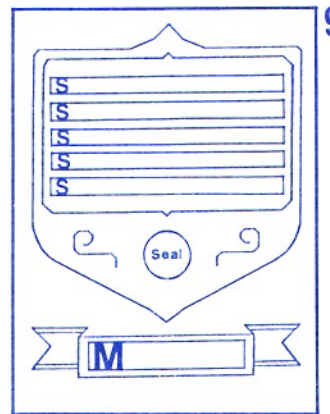
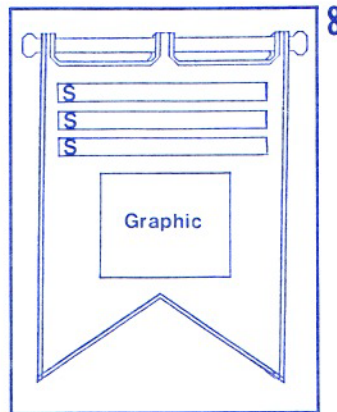
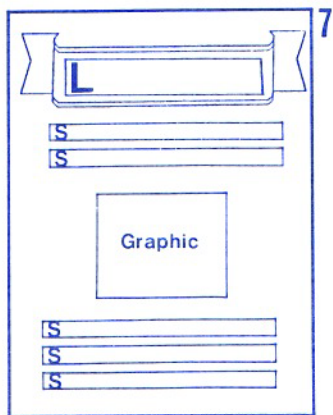
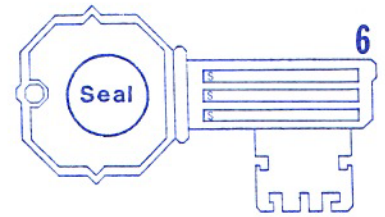
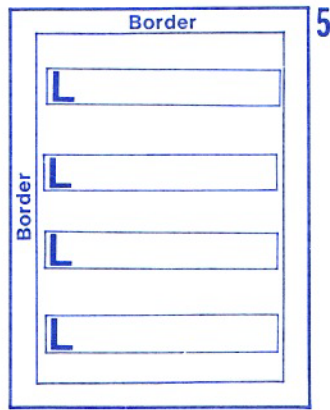
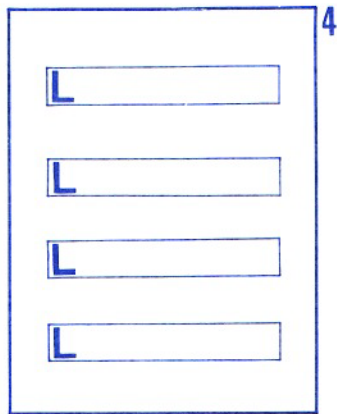
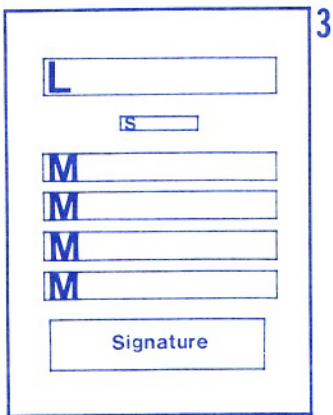

AWARDWARE MAIN MENU

Create an AwardDisk



With this feature, you can send an animated disk, that will also print out the award of your choice, to a friend with a compatible computer.

Apple/Atari/Commodore

Follow the same procedure for creating an award as you did in the Example Award (page 3 of this manual). After printing this award (to save it) make a copy of this program and send it to a friend. Tell them to choose "Edit Last Template" and print the award you created for them.

IBM and Compatibles

Make sure you have a formatted disk ready for use. If not, exit AwardWare, format a disk (being sure to use a disk that is not important to you), and then restart the AwardWare program to continue.

If you select "Dedicate Last Award", the program will automatically save the last award that was printed (there is a default award) onto the formatted disk that you provided. Please be patient; this procedure takes a few minutes.

If you select "Create New Award", follow the same procedure for creating awards on page 3 of this manual. Instead of choosing "Print", select "Create". Your newly created award will automatically be saved onto the formatted disk that you provided. Please be patient; this process takes a few minutes.

To see and test the AwardDisk you just created, exit AwardWare. Start AwardDisk the same as you would start AwardWare (see the Reference insert for instructions).

BE SURE TO COMPLETE PRINTER SETUP FIRST, then print the award.

After you have tested the AwardDisk, you may wish to return to *Printer Setup* and change the printer model to your friend's computer setup.

AWARDWARE DESIGN FEATURES

Borders



Borders are available in a wide variety of graphic designs. The placement of the border depends on the template design selected. In addition to these graphic borders, there are also text borders. These text borders are created by typing on your computer keyboard sayings like, "Cool Guy!", "I Love Ken", etc. You may choose the placement of the text border from the four sides of the award or any

combination of sides. The order is T (top), B (bottom), L (left), or R (right). The text border will replace borders on all template designs. "New Disk" are designs presently under development.

NOTE: Some border designs are not meant to be used on templates with corner borders only.

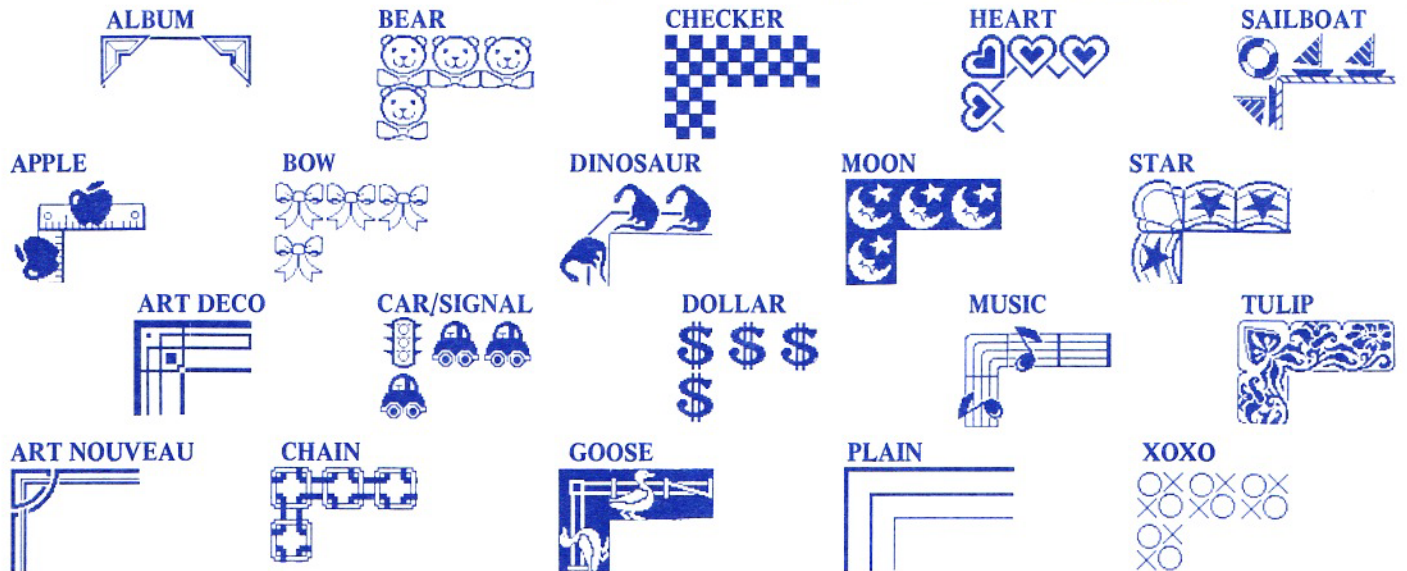

A list of fonts (type styles) will appear on the screen after choosing the "Text" option when creating an award. After choosing a font, type in your desired text. Make

sure the font chosen fits your template design. Please note that different styles and sizes of letters will vary the spacing of your text.

Block

Italic

Old English

Roman

Script

AWARDWARE DESIGN FEATURES

Graphics



Graphics are available in these fun and unique designs. Choose one that expresses the effect you would like to create when designing an award. If you wish to have

no graphic at all, choose "No Graphic". "New Disk" is for future graphic developments. Note that some computers have fewer graphics due to space limitations.

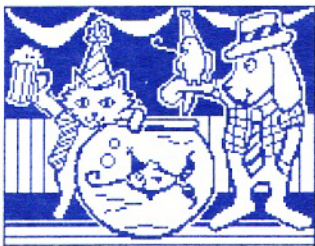

ANIMALS

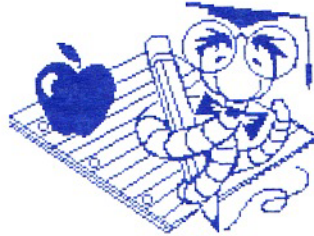

APPLE

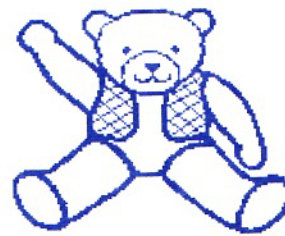

BEAR

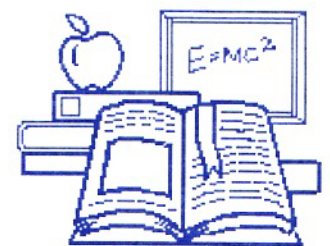

BOOK



BUTTERFLY



COMPUTER



DINOSAUR



DOGHOUSE

AWARDWARE DESIGN FEATURES

Graphics (continued)



DOLLAR



FLAG



GOOSE

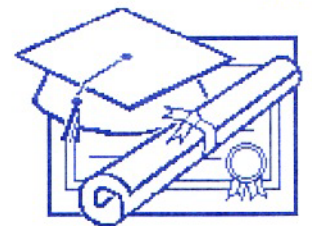

GRADUATION



HAND



HEART

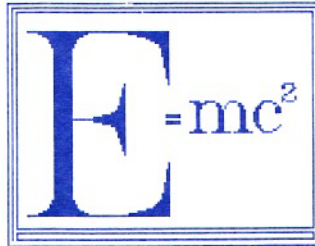

MATHEMATIC



MONEY BAG



MUSIC

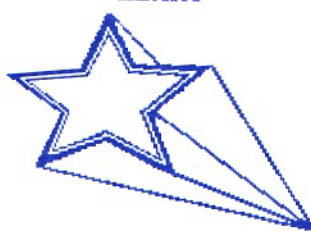

SHOOTING STAR

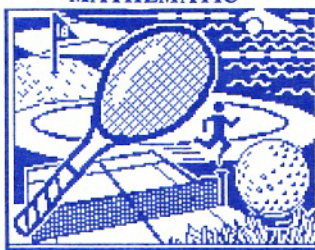

SPORTS



TEAM SPORTS

AWARDWARE DESIGN FEATURES

Seals/Signature



Seals are small graphic designs that can be used two different ways: First, as a small graphic used on many template designs such as checks, trophies, etc.; and Second, as part of the signature box.



BEAR



EWE'S GREAT



RIBBON



STAR



TERRIFIC

You have several "Signature" box choices when creating an award (as shown below). If "Left Side" or "Right Side" is chosen, you will be given a choice of Seals to add that "official" look to your award. If you would rather have a plain signature box, choose "No Seal". "New Disk" is for future developments of AwardWare.

OFFICIAL TITLE

SIGNATURE _____	DATE _____
TITLE _____	

LEFT SIDE

SIGNATURE _____	Seal
DATE _____	

RIGHT SIDE

Seal	SIGNATURE _____
	DATE _____

CENTERED

SIGNATURE _____
DATE _____

PROBLEM SOLVING/RE-ORDER INFORMATION



1. We suggest that you make a back up copy of the AwardWare program.
2. You must complete Printer Setup as your first step in designing awards. Repeat this step ONLY if you change printers.
3. If you have any problems while using the program or printing awards, complete the following checklist:
 - Make sure the printer is turned ON.
 - Make sure the printer is on-line and that all cables and connections are secure.
 - Turn printer OFF, then ON again.
 - Make sure the printer is set for your computer model.
4. If you are not sure that the correct Printer Setup was chosen, try the test for your Printer Setup (see the Reference insert for your computer type). If you are having further problems or your printer is not on the list, please send us your computer type and printer model numbers; the command summary from your printer manual; the printer manufacturer's name and address; and your name, address, and daytime phone number to the Technical Department of Hi Tech

Expressions, Inc. (see address below). We may be able to come up with some answers so that you too can use AwardWare.

5. Try rebooting the system, follow the steps on the Reference insert.
6. Use ONLY 8½ x 11 inch printer paper.
7. Boxes within some template designs are NOT accessible, we have already filled those in for you.
8. In printing awards, most text will be automatically centered.
9. Be sure your supply of printer paper is aligned in your printer correctly.

RE-ORDER INFORMATION

Send \$5.00 for each replacement disk or manual, be sure to specify which disk, computer type, or manual you would like to receive and send a check or money order to the Re-Order Department: Hi Tech Expressions, Inc., 1700 N.W. 65 Avenue, Suite 9, Plantation, Florida 33313.

ADDING FLAIR/MORE TO COME



1. Use the specially designed border paper from Hi Tech Expressions to add color and creativity to your awards.
2. See the front photo on the AwardWare package for examples of how we added flair to our awards.
3. Use different colors of printer paper.
4. Try using color markers, crayons, glitter, and ribbons to add pizzazz.
5. Cut out your awards, then paste them to construction paper or matt board, for framing.
6. Don't forget to sign your awards.

MORE TO COME

Look for the graphics expander disk, currently under development from Hi Tech Expressions. This disk will have a selection of more of those super graphics!

HI TECH EXPRESSIONS™

Celebrate Every Occasion On Computer And Make Print-Outs Too!

Available for Commodore 64/128, Atari 400/800, Apple IIc/e/+ and IBM.
IBM requires 256K and color graphics card, all others require 64K



AwardWare™

Design and Print Awards, Certificates, Ribbons, Tickets, Coupons, Checks & More! \$14.95

- Print traditional certificates, awards, licenses and announcements
- Create upbeat coupons, tickets, checks, stationery, memos or forms of any kind.
- 20 graphics to choose from
- Create Graphic & text borders
- Unique create-an-award-disk option.



CardWare™

All-Occasion Card Maker and Animated Birthday Greeting Disk \$9.95

- Print out greeting cards for birthdays and other special occasions
- Select from many graphics including a teddy bear, rocking horse, cake and more.
- Create your own personal message.
- Enjoy an animated musical birthday greeting.
- Create your own personalized greeting disks for others.



HeartWare™

Animated Friendship Greeting Disk and Love Note Maker \$9.95

- Print out greeting cards of friendship, love, and appreciation.
- Select from an assortment of graphics, like flowers, a rainbow, a butterfly and more.
- Create your own verse.
- Enjoy an animated musical friendship greeting.
- Copy the greeting onto another disk for friends.



PartyWare™

Design & Print Cards, Signs, Prizes, Banners, Placemats & Placecards. \$14.95

- Print invitations, thank you notes, and greeting cards for parties and other special occasions.
- Design your own party decorations, start to finish. Make banners, hats, placemats, games and more.
- Create your own animated cards, invitations, or greetings on computer disks.
- Remember every special occasion with the data base for names, addresses, birthdays, anniversaries, and other events.

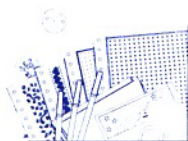

WareWithAll™

Designer Paper, Envelopes, Stickers, Markers, Disk & Disk Labels To Jazz Up All Your Computer Printouts \$14.95

- Use this colorful supply kit with CardWare™ HeartWare™ PartyWare™ Print Shop™ Newsroom™ and other printer software.
- Be creative, with the four-color rainbow pack of paper and envelopes.
- Decorate your letters and cards with the colored markers and assortment of stickers.
- Create your own computer greeting on the brightly colored disk.

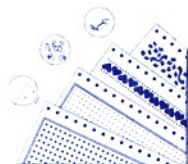

PrinterPaper™

Perfect For Greeting Cards, Banners, Letters, & Computer Creations Of All Kinds

Assortment Pack

- Four colorful paper designs – 150 sheets, \$9.95
- Stars
- Polka dots
- Confetti border
- Heart border
- Eight matching sticker designs – 24 stickers.

Holiday Pack

- Three colorful paper designs – 150 sheets, \$9.95
- Snowflakes all around border
- Holly border
- Christmas tree border
- Four matching sticker designs – 24 stickers.



Love Note Maker™

HeartWare and Heart Designer Paper Bundle \$14.95

- 100 sheets heart design paper.
- 16 coordinated stickers.
- HeartWare software program.



JingleDisk™

Holiday Card Maker & Animated Greeting Disk \$6.95

- New and Improved
- Makes more cards!
- Selection of full page and folded graphics for all your personalized season's greetings
- Unique disk-maker option

Available at mass merchandise, toy, book and computer retail stores.
Or use the enclosed order form.